

- > Ø 32 ... 100 mm
- > Cylinders and mountings conform to ISO 15552
- > Complete functional unit
- > Integrated 5/2 or 5/3 valve
- > Additional output ports (2 & 4)
- > Integrated flow regulator for speed control
- > Reed or solid state switches can be mounted flush with the profile barrel
- > Protection class IP65
- > Energy efficient

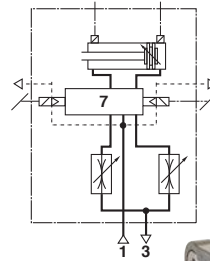

### Technical features

#### Medium:

Compressed air, filtered, lubricated or non-lubricated  
 Particles size: Class 7, ISO 8573 – 1 (dated 2001)  
 Humidity and water content: Air supply must be dry.  
 Corresponding of the application and working conditions the air must be dry enough to avoid condensate. The pressure dewpoint must be minimum 15° under the application and working conditions. Oil: Class 4, ISO 8573 – 1 (dated 2001)

#### Standard:

Based on ISO 15552 (length, mounting pitch and thread dimensions according to ISO 15552. Some outside dimensions different to ISO 15552)

#### Operation:

Double acting, magnetic piston, adjustable cushioning

#### Operating pressure:

2 ... 8 bar (29 ... 116 psi)

#### Port size:

G1/8, G1/4, G3/8

#### Cylinder diameters:

32, 40, 50, 63, 80, 100 mm

#### Standard strokes:

See below

#### Non-standard strokes:

Available (25 ... 1000 mm)

#### Operating temperature:

-5 ... +80°C max. (+23 ... +176°F)

#### Supply voltage:

24 V d.c. (±10 %) (other voltages supply on request)

#### Power consumption:

2 W max

#### Electrical connection:

DIN EN175301-803, form C

#### Manual override:

Turn and lock

#### Rating:

100 % E.D.

#### Protection class:

IP 65

#### Materials:

Profile barrel: anodised aluminium,  
 End covers: pressure diecast anodised aluminium  
 Piston rod: stainless steel, see page 2  
 Piston rod seals: PUR  
 Piston seals: PUR  
 O-rings: NBR



### Technical data

Cylinder Ø (mm)	32	40	50	63	80	100
Port size	G 1/8	G 1/8	G 1/8	G 1/4	G 1/4	G 3/8
Piston rod Ø (mm)	12	16	20	20	25	25
Piston rod thread	M10 x 1,25	M12 x 1,25	M16 x 1,5	M16 x 1,5	M20 x 1,5	M20 x 1,5
Cushion length (mm)	19	22	24	24	27	34
Theoretical thrusts at 6 bar outstroke (N)	482	754	1178	1870	3016	4710
Theoretical thrusts at 6 bar instroke (N)	414	633	990	1680	2722	4416
Air consumption at 6 bar outstroke (l/cm)	0,056	0,088	0,137	0,218	0,35	0,55
Air consumption at 6 bar instroke (l/cm)	0,05	0,076	0,117	0,198	0,324	0,514

### Standard strokes

Cylinder Ø (mm)	Stroke length (mm)										
	25	50	80	100	125	160	200	250	320	400	500
32	•	•	•	•	•	•	•	•	•	•	•
40	•	•	•	•	•	•	•	•	•	•	•
50	•	•	•	•	•	•	•	•	•	•	•
63	•	•	•	•	•	•	•	•	•	•	•
80	•	•	•	•	•	•	•	•	•	•	•
100	•	•	•	•	•	•	•	•	•	•	•
125	•	•	•	•	•	•	•	•	•	•	•

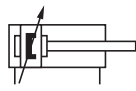
**Cylinder variants**

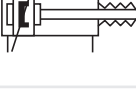
Symbol	R	S	C	D	Model with magnetic piston	Description	Dimensions Page
	•	•	•	•	PRA/862000/MI	Standard cylinder	7
	•	•	•	•	PRA/862000/W2	Cylinder with special wiper/seal (suitable for appl. with cement, plaster (stucco), arizona sand, hoar-frost or ice)	7
	•	•	•	•	PRA/862000/MU	Cylinder with extended piston rod	7
	•	•	•	•	PRA/862000/MG	Cylinder with piston rod below	8

For the cylinder models style C, D, and S see options selector

**Option selector**

**P★A/862★/★/★/213A/★/★**

<table border="1"> <thead> <tr> <th>Piston rod material</th> <th>Substitute</th> </tr> </thead> <tbody> <tr> <td>Stainless steel (martensitic); Standard wiper seal</td> <td><b>R</b></td> </tr> <tr> <td>Stainless steel (austenitic); Standard wiper seal</td> <td><b>S</b></td> </tr> <tr> <td>Hard chromium plated; Standard wiper seal</td> <td><b>C</b></td> </tr> <tr> <td>Stainless steel (austenitic); hard chromium plated; Standard wiper seal</td> <td><b>D</b></td> </tr> <tr> <td>Stainless steel (austenitic); Smooth wiper seal</td> <td><b>V</b></td> </tr> <tr> <td>Stainless steel (austenitic); hard chromium plated; Smooth wiper seal</td> <td><b>E</b></td> </tr> <tr> <th>Cylinder Ø (mm)</th> <th>Substitute</th> </tr> <tr> <td>032, 040, 050, 063, 080, 100</td> <td></td> </tr> <tr> <th>Variants (magnetic piston)</th> <th>Substitute</th> </tr> <tr> <td>Standard</td> <td><b>MI</b></td> </tr> <tr> <td>Piston rod below</td> <td><b>MG</b></td> </tr> <tr> <td>Special wiper seal</td> <td><b>W2</b></td> </tr> <tr> <td>Extended piston rod, P**/862***/MU/****/****</td> <td><b>MU</b></td> </tr> </tbody> </table>	Piston rod material	Substitute	Stainless steel (martensitic); Standard wiper seal	<b>R</b>	Stainless steel (austenitic); Standard wiper seal	<b>S</b>	Hard chromium plated; Standard wiper seal	<b>C</b>	Stainless steel (austenitic); hard chromium plated; Standard wiper seal	<b>D</b>	Stainless steel (austenitic); Smooth wiper seal	<b>V</b>	Stainless steel (austenitic); hard chromium plated; Smooth wiper seal	<b>E</b>	Cylinder Ø (mm)	Substitute	032, 040, 050, 063, 080, 100		Variants (magnetic piston)	Substitute	Standard	<b>MI</b>	Piston rod below	<b>MG</b>	Special wiper seal	<b>W2</b>	Extended piston rod, P**/862***/MU/****/****	<b>MU</b>	<table border="1"> <thead> <tr> <th>Strokes (mm)</th> <th>Substitute</th> </tr> </thead> <tbody> <tr> <td>1000 max.</td> <td></td> </tr> <tr> <th>Valve function *1)</th> <th>Substitute</th> </tr> <tr> <td>5/2 way solenoid/spring, cylinder instroke without current</td> <td><b>R</b></td> </tr> <tr> <td>5/2 way solenoid/spring, cylinder outstroke without current</td> <td><b>E</b></td> </tr> <tr> <td>5/2 way solenoid operated, solenoid return, bistable</td> <td><b>B</b></td> </tr> <tr> <td>5/3 way solenoid operated, solenoid return, all ports blocked (APB)</td> <td><b>A</b></td> </tr> <tr> <td>5/3 way solenoid operated, solenoid return, centre open exhaust (COE)</td> <td><b>C</b></td> </tr> </tbody> </table>	Strokes (mm)	Substitute	1000 max.		Valve function *1)	Substitute	5/2 way solenoid/spring, cylinder instroke without current	<b>R</b>	5/2 way solenoid/spring, cylinder outstroke without current	<b>E</b>	5/2 way solenoid operated, solenoid return, bistable	<b>B</b>	5/3 way solenoid operated, solenoid return, all ports blocked (APB)	<b>A</b>	5/3 way solenoid operated, solenoid return, centre open exhaust (COE)	<b>C</b>
Piston rod material	Substitute																																												
Stainless steel (martensitic); Standard wiper seal	<b>R</b>																																												
Stainless steel (austenitic); Standard wiper seal	<b>S</b>																																												
Hard chromium plated; Standard wiper seal	<b>C</b>																																												
Stainless steel (austenitic); hard chromium plated; Standard wiper seal	<b>D</b>																																												
Stainless steel (austenitic); Smooth wiper seal	<b>V</b>																																												
Stainless steel (austenitic); hard chromium plated; Smooth wiper seal	<b>E</b>																																												
Cylinder Ø (mm)	Substitute																																												
032, 040, 050, 063, 080, 100																																													
Variants (magnetic piston)	Substitute																																												
Standard	<b>MI</b>																																												
Piston rod below	<b>MG</b>																																												
Special wiper seal	<b>W2</b>																																												
Extended piston rod, P**/862***/MU/****/****	<b>MU</b>																																												
Strokes (mm)	Substitute																																												
1000 max.																																													
Valve function *1)	Substitute																																												
5/2 way solenoid/spring, cylinder instroke without current	<b>R</b>																																												
5/2 way solenoid/spring, cylinder outstroke without current	<b>E</b>																																												
5/2 way solenoid operated, solenoid return, bistable	<b>B</b>																																												
5/3 way solenoid operated, solenoid return, all ports blocked (APB)	<b>A</b>																																												
5/3 way solenoid operated, solenoid return, centre open exhaust (COE)	<b>C</b>																																												

Note: This options selector explains only the cylinder variants. For combinations of cylinder variants consult our technical service.

\*1) Version with pilot operated valves on request.

**Reduced Installation Time & Cost**

To connect the IVAC you simply run a single ring main to provide an air supply to each unit. There is no mounting of valve islands to the machine framework or inside a cabinet and there is no pipework to run around the machine to connect each valve to each actuator

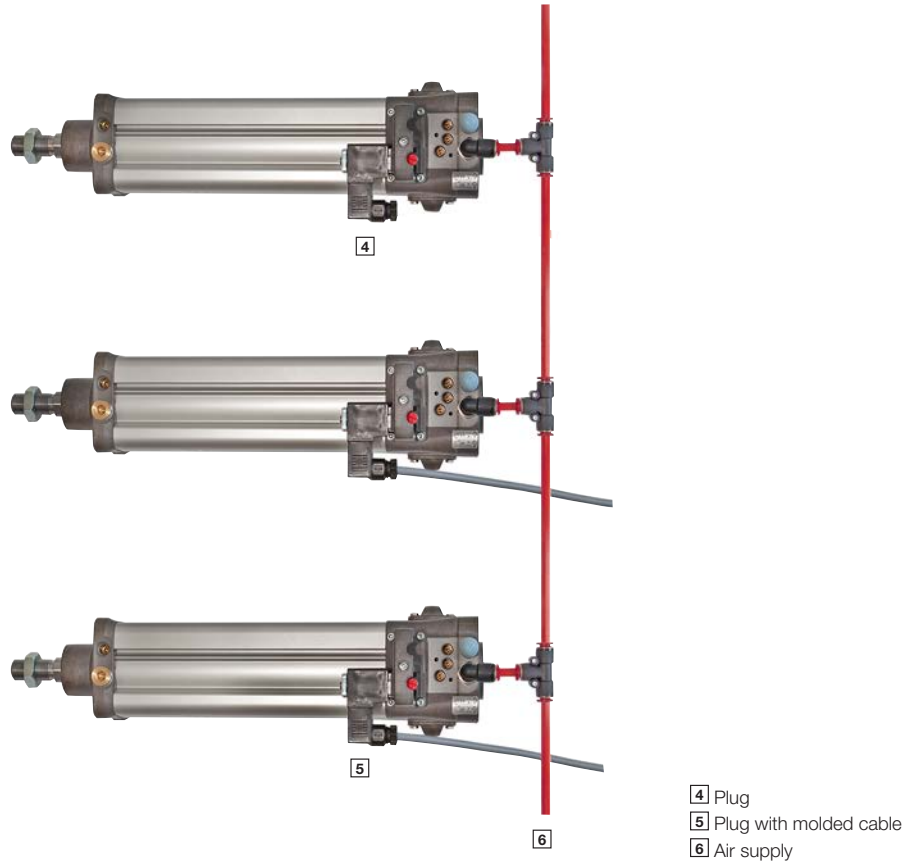

One of the advantages of the IVAC cylinders is to use the output ports (2 & 4) from the main valve to operate an additional cylinder.

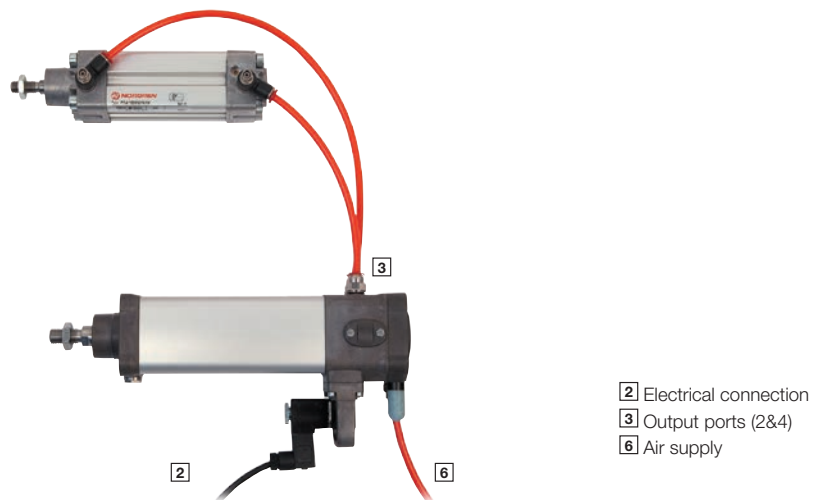

## Mountings

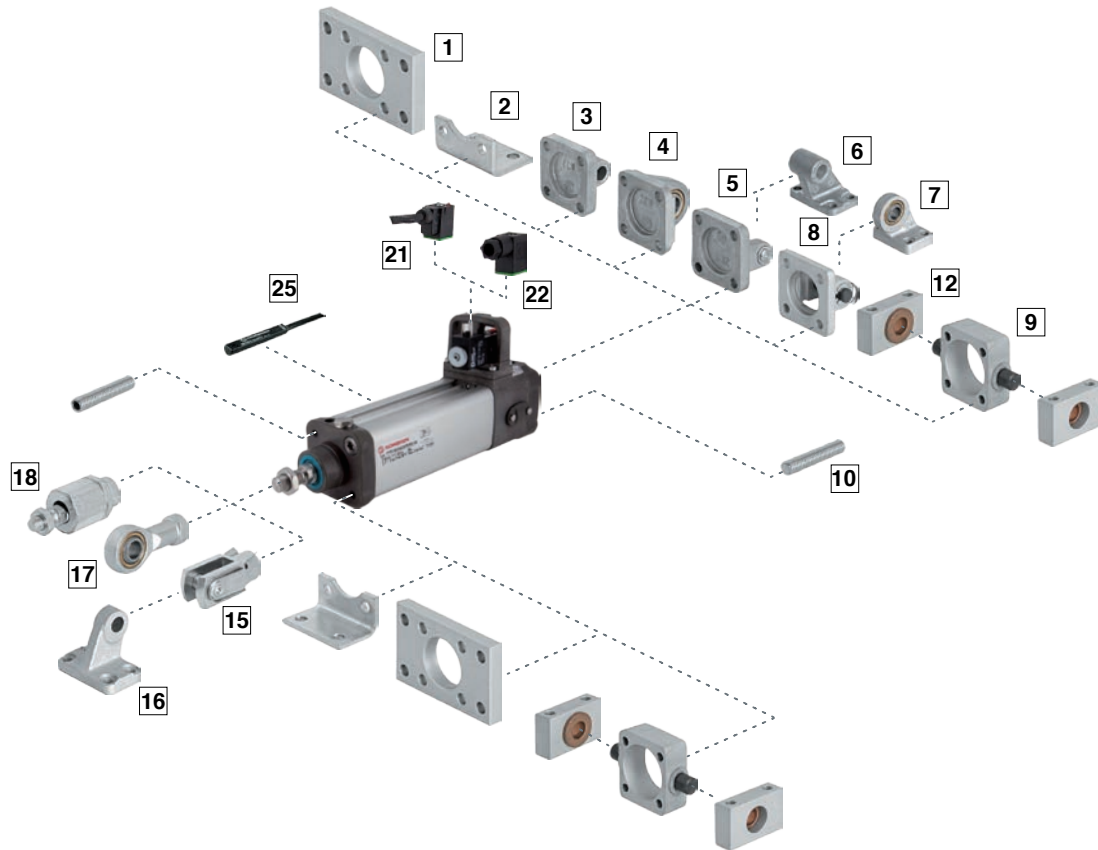

Position	Style	Standard	Corrosion protected
1	B, G	Clear anodised aluminium	Clear anodised aluminium. Screws: A2
2	C	Galvanized steel (ø 32 ... 63 mm) Painted steel (ø 80 & 100 mm)	—
3	R	Diecast aluminium	Black corrosion protected diecast aluminium. Certified for the food industry. Screws: A2
4	UR	Galvanized aluminium Inner ring: steel Outer ring: brass	Black corrosion protected diecast aluminium Certified for the food industry Inner ring: stainless Steel (austenitic) Outer ring: nickel plated hardened steel
5	D	Diecast aluminium Bolt: galvanized steel (martensitic) Circlip: galvanized steel	Black corrosion protected diecast aluminium Certified for the food industry Bolt: X 10 Cr Ni S 18 9 (1.4305, AISI 303) Circlip: Stainless steel (martensitic). Screws: A2
6	SW	Diecast aluminium	Black corrosion protected diecast aluminium Certified for the food industry
7	US	Galvanized aluminium. Inner ring: steel Outer ring: brass	—
8	D2	Painted cast iron. Bolt: stainless steel (martensitic) Circlip: galvanized steel	—
9	FH	Cast iron	—
10	A	Galvanized steel	—
11	Screw	—	—
12	S	Clear anodised aluminium Bearing: brass	—
15	F	Galvanized steel Bolt: galvanized steel Circlip: Galvanized steel	Nickel plated steel Circlip: X 10 Cr Ni S 18 9 (1.4305, AISI 303) Bolt: X 10 Cr Ni S 18 9 (1.4305, AISI 303)
16	SS	Painted cast iron	—
17	UF	Galvanized steel. Inner ring: steel Outer ring: brass	Nickel plated steel. Inner ring: stainless steel (austenitic) Outer ring: nickel plated hardened steel.
18	AK	Galvanized steel	—

### Mountings

Model	A	AK	B, G	C	D	D2	F	FH
<b>Cyl. Ø</b>	<b>10</b>	<b>18</b>	<b>1</b>	<b>2</b>	<b>5</b>	<b>8</b>	<b>15</b>	<b>9</b>
	<b>Page 9</b>	<b>Page 9</b>	<b>Page 9</b>	<b>Page 9</b>	<b>Page 9</b>	<b>Page 9</b>	<b>Page 10</b>	<b>Page 10</b>
32	QM/8032/35	QM/8025/38	QA/8032/22	QA/8032/21	QA/8032/23	QA/8032/42	QM/8025/25	QA/8032/34
40	QM/8032/35	QM/8040/38	QA/8040/22	QA/8040/21	QA/8040/23	QA/8040/42	QM/8040/25	QA/8040/34
50	QM/8050/35	QM/8050/38	QA/8050/22	QA/8050/21	QA/8050/23	QA/8050/42	QM/8050/25	QA/8050/34
63	QM/8050/35	QM/8050/38	QA/8063/22	QA/8063/21	QA/8063/23	QA/8063/42	QM/8050/25	QA/8063/34
80	QM/8080/35	QM/8080/38	QA/8080/22	QA/8080/21	QA/8080/23	QA/8080/42	QM/8080/25	QA/8080/34
100	QM/8080/35	QM/8080/38	QA/8100/22	QA/8100/21	QA/8100/23	QA/8100/42	QM/8080/25	QA/8100/34
<b>Corrosion protected</b>								
32	—	—	PVQA/8032/22	—	PVQA/8032/23	—	PVQM/8025/25	—
40	—	—	PVQA/8040/22	—	PVQA/8040/23	—	PVQM/8040/25	—
50	—	—	PVQA/8050/22	—	PVQA/8050/23	—	PVQM/8050/25	—
63	—	—	PVQA/8063/22	—	PVQA/8063/23	—	PVQM/8050/25	—
80	—	—	PVQA/8080/22	—	PVQA/8080/23	—	PVQM/8080/25	—
100	—	—	PVQA/8100/22	—	PVQA/8100/23	—	PVQM/8080/25	—
Model	R	S	SS	SW	UF	UR	US	
<b>Cyl. Ø</b>	<b>3</b>	<b>12</b>	<b>16</b>	<b>6</b>	<b>17</b>	<b>4</b>	<b>7</b>	
	<b>Page 10</b>	<b>Page 10</b>	<b>Page 11</b>	<b>Page 11</b>	<b>Page 10</b>	<b>Page 11</b>	<b>Page 12</b>	
32	QA/8032/27	QA/8032/41	M/P19931	M/P19493	QM/8025/32	QA/8032/33	M/P40310	
40	QA/8040/27	QA/8040/41	M/P19932	M/P19494	QM/8040/32	QA/8040/33	M/P40311	
50	QA/8050/27	QA/8040/41	M/P19933	M/P19495	QM/8050/32	QA/8050/33	M/P40312	
63	QA/8063/27	QA/8063/41	M/P19934	M/P19496	QM/8050/32	QA/8063/33	M/P40313	
80	QA/8080/27	QA/8063/41	M/P19935	M/P19497	QM/8080/32	QA/8080/33	M/P40314	
100	QA/8100/27	QA/8100/41	M/P19936	M/P19498	QM/8080/32	QA/8100/33	M/P40315	
<b>Corrosion protected</b>								
32	PVQA/8032/27	—	—	M/P40459	PVQM/8025/32	PVQA/8032/33	—	
40	PVQA/8040/27	—	—	M/P40460	PVQM/8040/32	PVQA/8040/33	—	
50	PVQA/8050/27	—	—	M/P40461	PVQM/8050/32	PVQA/8050/33	—	
63	PVQA/8063/27	—	—	M/P40462	PVQM/8050/32	PVQA/8063/33	—	
80	PVQA/8080/27	—	—	M/P40463	PVQM/8080/32	PVQA/8080/33	—	
100	PVQA/8100/27	—	—	M/P40464	PVQM/8080/32	PVQA/8100/33	—	

### Connectors

Plug with cable gland	Plug with molded cable	Magnetically operated switches
<b>21</b>	<b>22</b>	<b>25</b>
V10027-D00	V10014-D01 (LED and VDR, cable leng h 1 m)	Pages 12 & 13
V10012-D13 (LED and VDR)	V10014-D03 (LED and varistor, cable leng h 3 m)	

### Service kit

Service kit	
<b>Cyl. Ø</b>	
32	PRQA/862032/00
40	PRQA/862040/00
50	PRQA/862050/00
63	PRQA/862063/00
80	PRQA/862080/00
100	PRQA/862100/00

Dimensions

Dimensions in mm  
Projection/First angle

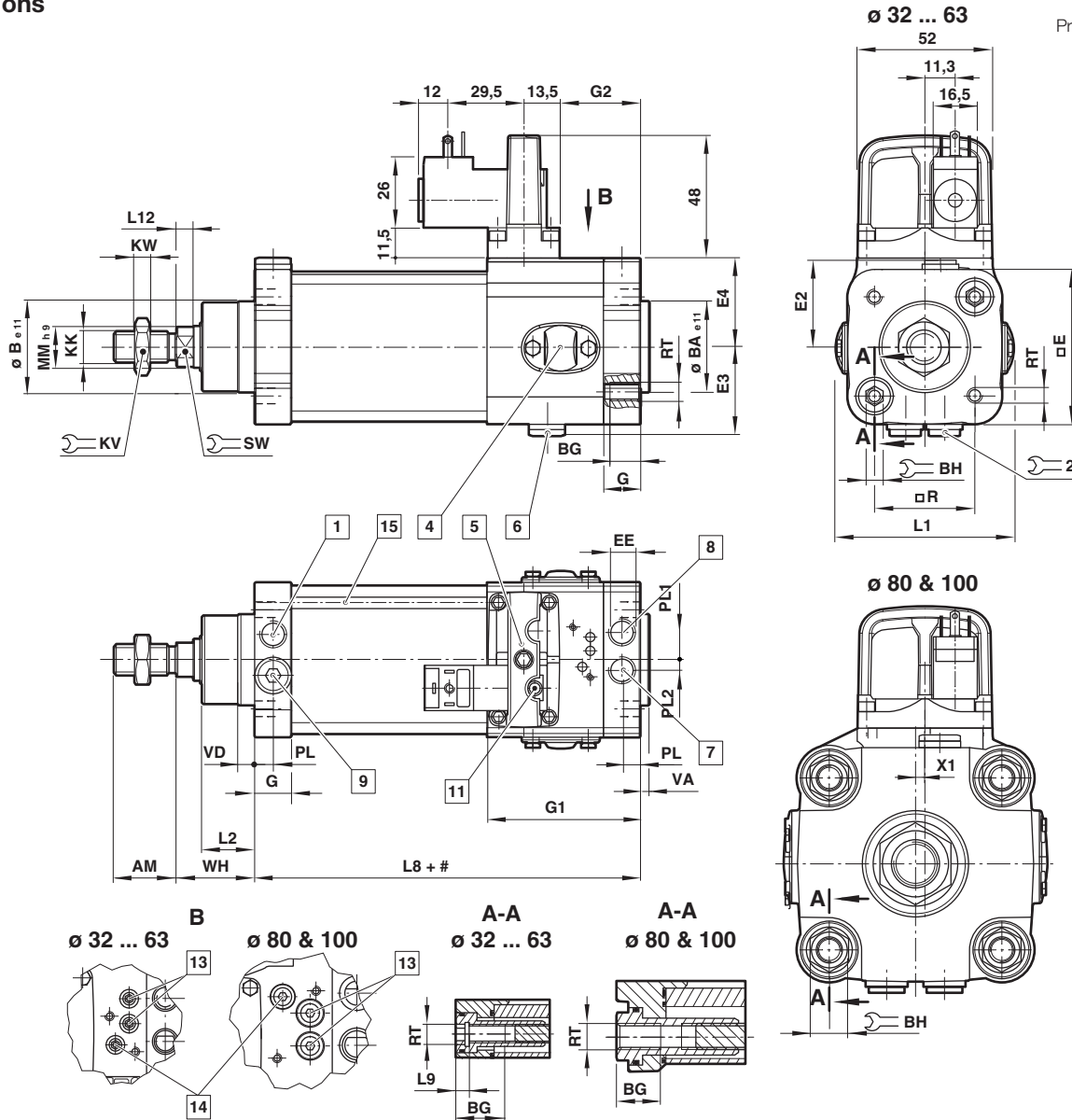



# Stroke

- 1 Cushion adjustment front end cover
- 4 Main valve
- 5 Pilot block
- 6 Output ports (2&4)

- 7 Air supply
- 8 Exhaust position, do not obstruct
- 9 Without function - do not use
- 11 Manual override
- 13 Speed control adjustment

- 14 Cushion adjustment rear end cover
- 15 M/50 switches can be mounted flush with the profile  
Attention: Reed switches for Ø 40 ... 100 mm useable only

Ø	AM	Ø B e11	Ø BA e11	BG	BH	□ E	E2	E3	E4	EE	G	G1	G2	KK	KW	L1	L2	L8	L9	L12
32	22	30	30	16	6	53	31	30,5	32	G1/8	14	59	30,5	M10x1,25	5	68,5	20	94	4	4,5
40	24	35	35	16	6	60	34,5	34	34	G1/8	14	59	30,5	M12x1,25	6	68,5	21	105	4	6,5
50	32	40	40	16	8	71,5	40	39	39	G1/8	14	63	34,5	M16x1,5	8	92,5	28	106	5	6,5
63	32	45	45	16	8	82	46	45,5	45,5	G1/4	19	66	38	M16x1,5	8	91,5	28	121	5	6,5
80	40	45	45	17	19	99	54	54	57	G1/4	19	74,5	46,5	M20x1,5	10	110	35	128	-	7,5
100	40	55	55	17	19	119	65	65	65	G3/8	24,5	81	53	M20x1,5	10	144,5	38	138	-	10
Ø	Ø MM	PL	PL1	PL2	□ R	RT	VA	VD	WH	X1				at 0 mm		per 25 mm		Model		
32	12	7	10,5	4	32,5	M 6	3	6	26	0	17	10	5	0,66 kg	0,07 kg	PRA/862032/MI+/213A/*				
40	16	7	10,5	4	38	M 6	3,5	6	30	0	19	13	5	1,03 kg	0,11 kg	PRA/862040/MI+/213A/*				
50	20	7	12,5	4	46,5	M 8	3,5	6	37	1,5	24	17	5	1,58 kg	0,18 kg	PRA/862050/MI+/213A/*				
63	20	9,5	14,5	6	56,5	M 8	4	6	37	0	24	17	6	2,42 kg	0,19 kg	PRA/862063/MI+/213A/*				
80	25	9,5	14	6	72	M 10	4	6	46	6	30	22	6	4,12 kg	0,29 kg	PRA/862080/MI+/213A/*				
100	25	12	16,5	8,5	89	M 10	4	6	51	6,5	30	22	8	6,34 kg	0,35 kg	PRA/862100/MI+/213A/*				

\* Please insert standard stroke length  
+ Please insert valve function

**P.A/862000/MG./213A/.; Cylinder with piston rod bellow**

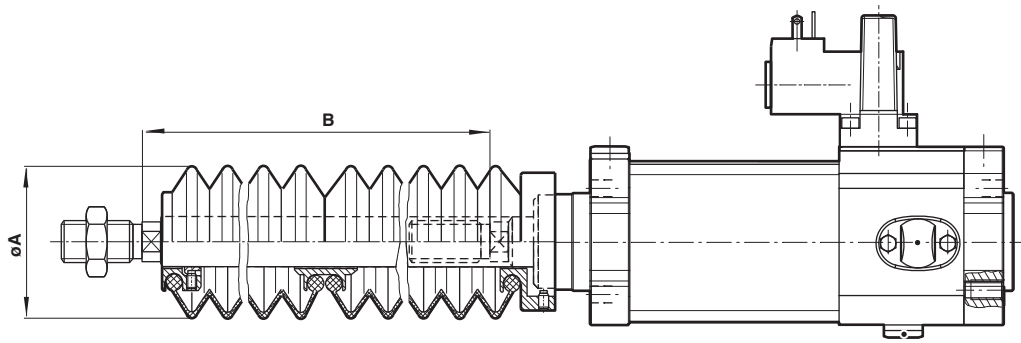
 Dimensions in mm  
Projection/First angle

Cyl. $\varnothing$	$\varnothing A$	Stroke max	Piston rod extention B		Model
			for first bellow	for further bellows	
32	40	60	30	25	P#/A/862032/MG+/213A/*
40	63	145	50	32	P#/A/862040/MG+/213A/*
50	63	145	40	32	P#/A/862050/MG+/213A/*
63	63	145	40	32	P#/A/862063/MG+/213A/*
80	80	250	50	45	P#/A/862080/MG+/213A/*
100	80	250	50	45	P#/A/862100/MG+/213A/*

\* Standard stroke length

# Piston rod material

+ Valve function

**Mountings**

**Front or rear stud mounting A**

Conforms to ISO 15552, type MX1

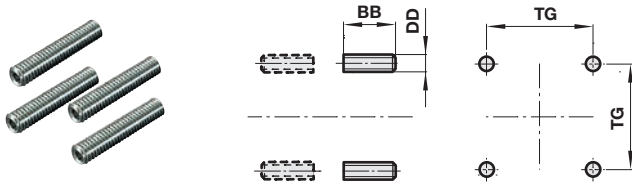

**Standard**

Ø	BB	DD	TG	kg	Model (A)
32/40	17	M6	32,5/38	0,02	QM/8032/35
50/63	23	M8	46,5/56,5	0,05	QM/8050/35
80/100	28	M10	72/89	0,08	QM/8080/35

**Front flange B, G**

Conforms to ISO 15552, type MF1 and MF2

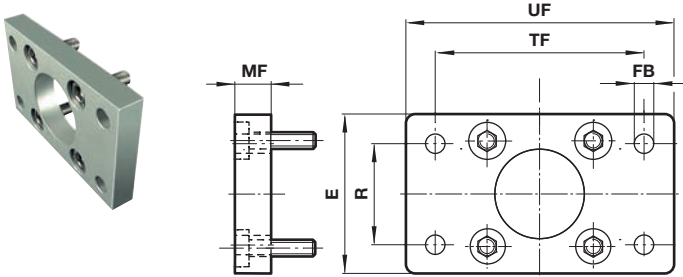

**Standard**

Ø	E	Ø FB	MF	R	TF	UF	kg	Model (B, G)
32	50	7	10	32	64	80	0,25	QA/8032/22
40	55	9	10	36	72	90	0,35	QA/8040/22
50	65	9	12	45	90	110	0,70	QA/8050/22
63	75	9	12	50	100	125	0,80	QA/8063/22
80	100	12	16	63	126	154	1,35	QA/8080/22
100	120	14	16	75	150	186	2,20	QA/8100/22

**Corrosion protected version**

32	50	7	10	32	64	80	0,25	PVQA/8032/22
40	55	9	10	36	72	90	0,35	PVQA/8040/22
50	65	9	12	45	90	110	0,7	PVQA/8050/22
63	75	9	12	50	100	125	0,8	PVQA/8063/22
80	100	12	16	63	126	154	1,35	PVQA/8080/22
100	120	14	16	75	150	186	2,2	PVQA/8100/22

**Piston rod swivel AK**

Dimensions in mm  
Projection/First angle

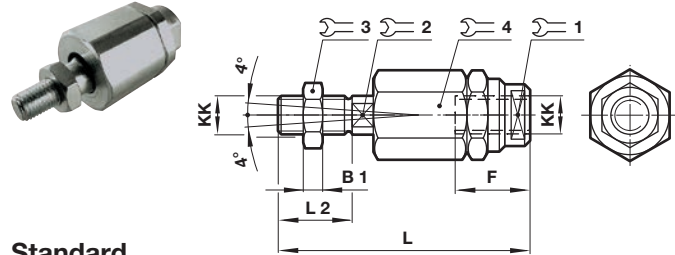

**Standard**

Ø	KK	B1	F	L	L2					kg	Model (AK)
						1	2	3	4		
32	M10x1,25	5	26	73	20	19	12	17	30	0,20	QM/8025/38
40	M12x1,25	6	26	77	24	19	12	19	30	0,20	QM/8040/38
50/63	M16x1,5	8	34	106	32	30	19	24	42	0,65	QM/8050/38
80/100	M20x1,5	10	42	122	40	30	19	30	42	0,72	QM/8080/38

**Foot mounting C**

Conforms to ISO 15552, type MS1

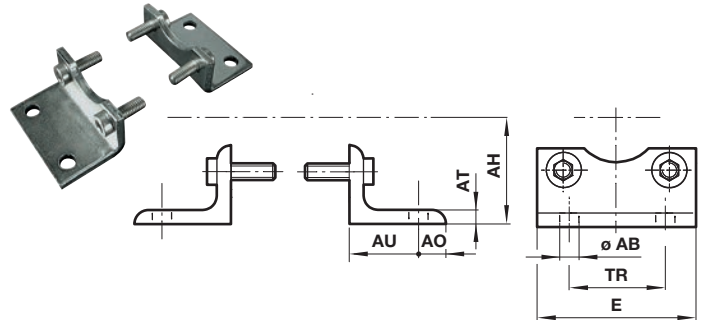

**Standard**

Ø	Ø AB	AH	AO	AT	AU	E	TR	kg	Model (C)
32	7	32	8	4	24	48	32	0,15	QA/8032/21
40	10	36	9	4	28	53	36	0,18	QA/8040/21
50	10	45	10	5	32	64	45	0,30	QA/8050/21
63	10	50	12	5	32	74	50	0,39	QA/8063/21
80	12	63	19	5	41	98	63	0,80	QA/8080/21
100	14	71	19	5	41	115	75	0,95	QA/8100/21

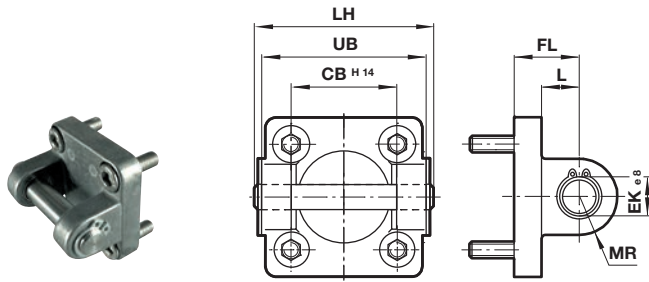

**Rear clevis D**  
**Conforms to ISO 15552, type MP2**

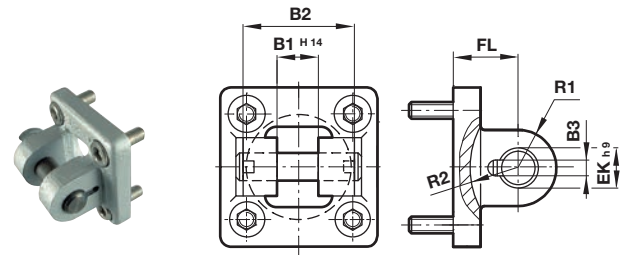
**Rear clevis D2**  
**Conforms to ISO 15552, type AB6**

 Dimensions in mm  
 Projection/First angle

**Standard**

Ø	CB H14	Ø EK e8	FL	L	LH	MR	UB	kg	Model (D)
32	26	10	22	13	52	9	45	0,11	QA/8032/23
40	28	12	25	16	60	12	52	0,16	QA/8040/23
50	32	12	27	17	68	12	60	0,22	QA/8050/23
63	40	16	32	22	79	15	70	0,34	QA/8063/23
80	50	16	36	22	99	15	90	0,54	QA/8080/23
100	60	20	41	27	119	20	110	0,90	QA/8100/23
<b>Corrosion protected version</b>									
32	26	10	22	13	52	9	45	0,11	PVQA/8032/23
40	28	12	25	16	60	12	52	0,16	PVQA/8040/23
50	32	12	27	17	68	12	60	0,22	PVQA/8050/23
63	40	16	32	22	79	15	70	0,34	PVQA/8063/23
80	50	16	36	22	99	15	90	0,54	PVQA/8080/23
100	60	20	41	27	119	20	110	0,9	PVQA/8100/23

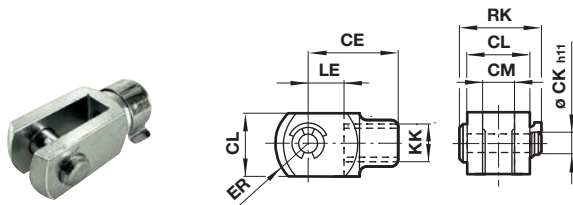
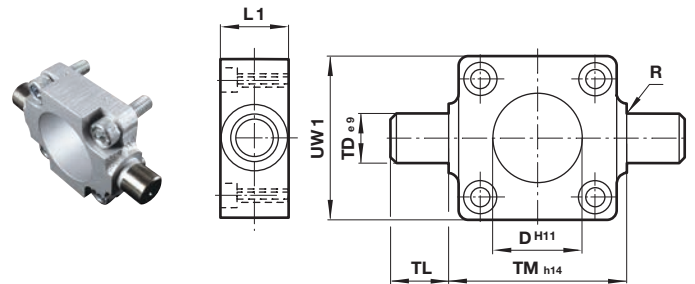
**Standard**

Ø	B1 H14	B2	B3	Ø EK h9	FL	R1	R2	kg	Model (D2)
32	14	34	3,3	10	22	11	17	0,20	QA/8032/42
40	16	40	4,3	12	25	12	20	0,23	QA/8040/42
50	21	45	4,3	16	27	14,5	22	0,36	QA/8050/42
63	21	51	4,3	16	32	18	25	0,55	QA/8063/42
80	25	65	4,3	20	36	22	30	0,90	QA/8080/42
100	25	75	4,3	20	41	22	32	1,45	QA/8100/42

**Piston rod clevis F**  
**Conforms to DIN ISO 8140**

**Front or rear detachable trunnion FH**  
**Conforms to VDMA 24562 part 2,  
type MT 5/6**

**Standard**

Ø	KK	CE	Ø CK h11	CL	CM	ER	LE	RK	kg	Model (F)
32	M10x1,25	40	10	20	10	16	20	28	0,09	QM/8025/25
40	M12x1,25	48	12	24	12	19	24	32	0,13	QM/8040/25
50/63	M16x1,5	64	16	32	16	25	32	41,5	0,33	QM/8050/25
80/100	M20x1,5	80	20	40	20	32	40	50	0,67	QM/8080/25
<b>Corrosion protected version</b>										
32	M10x1,25	40	10	20	10	16	20	28	0,09	PVQM/8032/25
40	M12x1,25	48	12	24	12	19	24	32	0,13	PVQM/8040/25
50/63	M16x1,5	64	16	32	16	25	32	41,5	0,33	PVQM/8050/25
80/100	M20x1,5	80	20	40	20	32	40	50	0,67	PVQM/8080/25

**Standard**

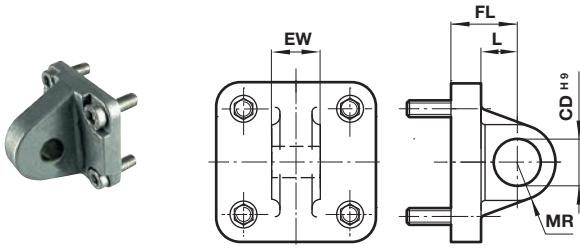
Ø	Ø D h11	L1	R	Ø TD e9	TL	TM h14	UW1	kg	Model (FH)
32	30	16	1	12	12	50	45	0,20	QA/8032/34
40	35	20	1,6	16	16	63	55	0,38	QA/8040/34
50	40	24	1,6	16	16	75	65	0,60	QA/8050/34
63	45	24	1,6	20	20	90	75	1,10	QA/8063/34
80	45	28	1,6	20	20	110	100	1,90	QA/8080/34
100	55	38	2	25	25	132	120	3,50	QA/8100/34

**Rear eye R**  
Conforms to ISO 15552, type MP4



**Trunnion support S**  
Conforms to ISO 15552, type AT4

Dimensions in mm  
Projection/First angle

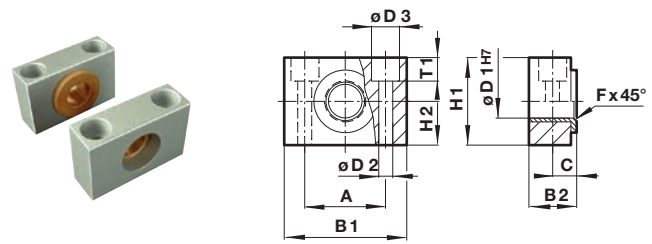

**Standard**

Ø	Ø CD H9	EW	FL	L	MR	kg	Model (R)
32	10	25,8	22	13	9	0,09	QA/8032/27
40	12	27,8	25	16	12	0,11	QA/8040/27
50	12	31,7	27	17	12	0,17	QA/8050/27
63	16	39,7	32	22	15	0,24	QA/8063/27
80	16	49,7	36	22	15	0,37	QA/8080/27
100	20	59,7	41	27	20	0,59	QA/8100/27
<b>Corrosion protected version</b>							
32	10	25,8	22	13	9	0,09	PVQA/8032/27
40	12	27,8	25	16	12	0,11	PVQA/8040/27
50	12	31,7	27	17	12	0,17	PVQA/8050/27
63	16	39,7	32	22	15	0,24	PVQA/8063/27
80	16	49,7	36	22	15	0,37	PVQA/8080/27
100	20	59,7	41	27	20	0,59	PVQA/8100/27

**Standard**

Ø	A	B	1	2	C	Ø D1 H7	Ø D2	Ø D3	Fx 45°	H	1	2	T1	kg	Model (S)
32	32	46	18	10,5	12	6,6	11	1	30	15	6,8	0,10	QA/8032/41		
40/50	36	55	21	12	16	9	15	1,6	36	18	9	0,14	QA/8040/41		
63/80	42	65	23	13	20	11	18	1,6	40	20	11	0,18	QA/8063/41		
100	50	75	28,5	16	25	14	20	2	50	25	13	0,34	QA/8100/41		

**Universal piston rod eye UF**  
Conforms to DIN ISO 8139

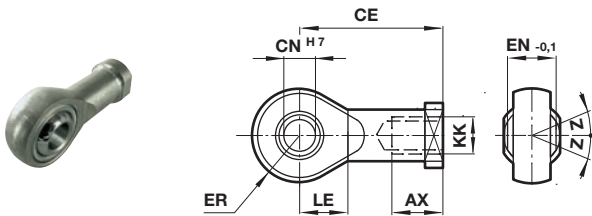

**Wide hinge SW**  
Conforms to ISO 15552, type AB7

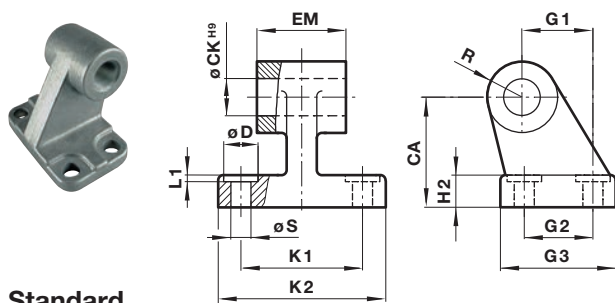

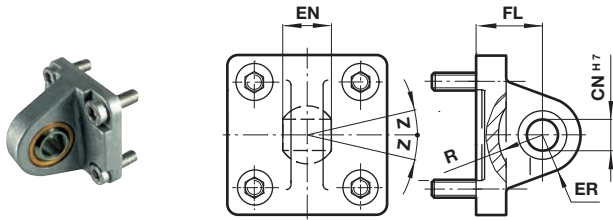
**Universal rear eye UR  
Conforms to ISO 15552, type MP6**

**Standard**

Ø	Ø CN H7	EN	ER	FL	R	Z	kg	Model (UR)
32	10	14	16	22	14,5	13°	0,15	QA/8032/33
40	12	16	18	25	18	13°	0,25	QA/8040/33
50	16	21	21	27	19	15°	0,40	QA/8050/33
63	16	21	23	32	24	15°	0,55	QA/8063/33
80	20	25	28	36	24	15°	0,90	QA/8080/33
100	20	25	30	41	29	15°	1,50	QA/8100/33
<b>Corrosion protected version</b>								
32	10	14	16	22	14,5	13°	0,15	PVQA/8032/33
40	12	16	19	25	18	13°	0,25	PVQA/8040/33
50	16	21	21	27	19	13°	0,4	PVQA/8050/33
63	16	21	24	32	24	15°	0,55	PVQA/8063/33
80	20	25	28	36	24	15°	0,9	PVQA/8080/33
100	20	25	30	41	29	15°	1,5	PVQA/8100/33

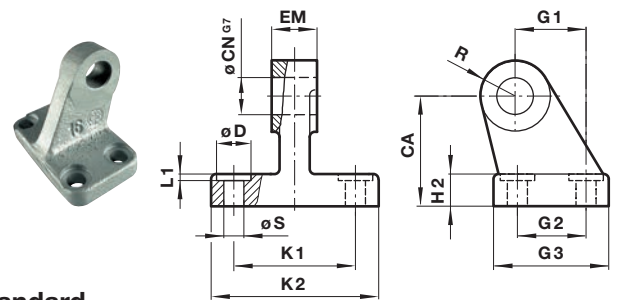
**Narrow hinge SS**

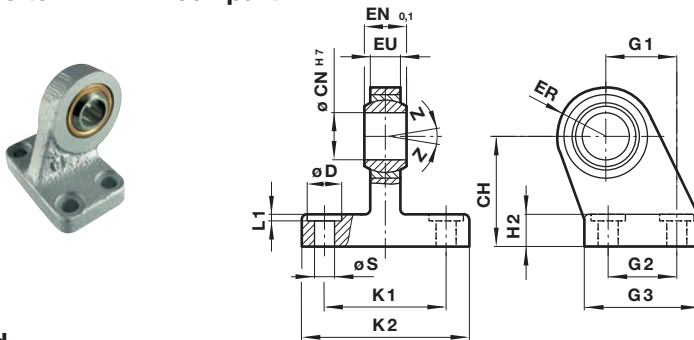

 Dimensions in mm  
Projection/First angle

**Standard**

Ø	CA	Ø CN G7	Ø D	H 2	EM 1	G 2	G 3	K 1	K 2	L 1	R	Ø S	kg	Model (SS)	
32	32	10	11	8	10	21	18	31	38	51	1,6	10	6,6	0,15	M/P19931
40	36	12	11	10	12	24	22	35	41	54	1,6	11	6,6	0,20	M/P19932
50	45	16	15	12	16	33	30	45	50	65	1,6	13	9	0,48	M/P19933
63	50	16	15	12	16	37	35	50	52	67	1,6	15	9	0,50	M/P19934
80	63	20	18	14	20	47	40	60	66	86	2,5	15	11	0,75	M/P19935
100	71	20	18	15	20	55	50	70	76	96	2,5	19	11	1,20	M/P19936

**Swivel hinge US  
Conforms to VDMA 24562 part 2**

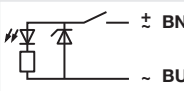
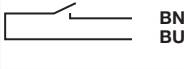
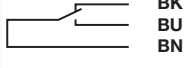
**Standard**

Ø	CH	Ø CN H7	Ø D	EN -0,1	ER	EU	G1	G2	G3	H2	K1	K2	L1	Ø S	Z	kg	Model (US)
32	32	10	11	14	16	10,5	21	18	31	10	38	51	1,6	6,6	13°	0,19	M/P40310
40	36	12	11	16	18	12	24	22	35	10	41	54	1,6	6,6	13°	0,24	M/P40311
50	45	16	15	21	21	15	33	30	45	12	50	65	1,6	9	13°	0,46	M/P40312
63	50	16	15	21	23	15	37	35	50	12	52	67	1,6	9	15°	0,59	M/P40313
80	63	20	18	25	28	18	47	40	60	14	66	86	2,5	11	15°	1,03	M/P40314
100	71	20	18	25	30	18	55	50	70	15	76	96	2,5	11	15°	1,40	M/P40315

**Technical data - Reed switches - additional informations see data sheet N/en 4.3.005**

Symbol	Voltage		Current maximum (mA)	Function	Temperature (°C)	LED	Protection class	Plug	Cable length (m)	Cable type	Weight (g)	Model
	(V a.c.)	(V d.c.)										
	10 ... 240	10 ... 170	180	Closer	-25 ... +80	•	IP66	—	2, 5 or 10	PVC 2 x 0,25	37	M/50/LSU/*V
	10 ... 240	10 ... 170	180	Closer	-25 ... +80	•	IP66	—	5	PUR 2 x 0,25	37	M/50/LSU/5U
	10 ... 240	10 ... 170	180	Closer	-25 ... +150	—	IP66	—	2	Silicon 2 x 0,25	37	TM/50/RAU/2S
	10 ... 240	10 ... 170	180	Changeover	-25 ... +80	—	IP66	—	5	PVC 3 x 0,25	37	M/50/RAC/5V
	10 ... 60	10 ... 60	180	Closer	-25 ... +80	•	IP66	M8 x 1	0,3	PVC 3 x 0,25	16	M/50/LSU/CP *1)

\* Insert cable length; \*1) Plug-in connector see page 11; Color code: BK = black, BN = brown, BU = blue

**Drawings**

M/50/LSU/\*V, M/50/LSU/5U,  
TM/50/RAU/2S  
Cable length L = 2, 5 or 10 m

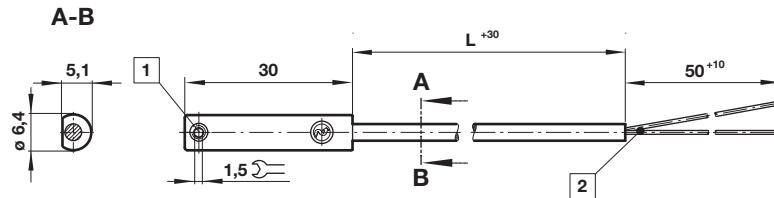

M/50/RAC/5V  
Cable length L = 5 m

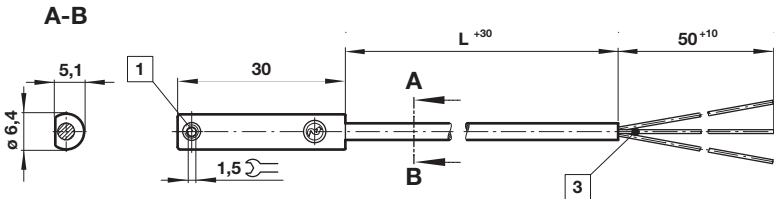

M/50/LSU/CP

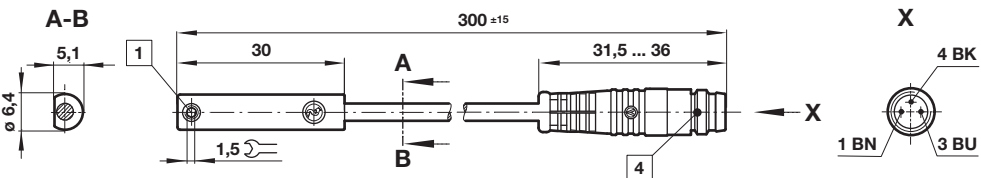

- 1 Fixing screw
- 2 + BN = brown; - BU = blue (output)
- 3 - BK = black; + BN = brown; - ≠BU = blue
- 4 Plug M8 x 1, color code: BK = black; BN = brown; BU = blue

Dimensions in mm  
Projection/First angle



**Accessories**

Plug-in connector cable with nut



Outer cover	Cable length (m)	Weight (kg)	Connector	Connector
PVC 3 x 0,25	5 m	0,18	M8 x 1	M/P73001/5
PUR 3 x 0,25	5 m	0,18	M8 x 1	M/P73002/5
PUR 3 x 0,34	5 m	0,21	M12 x 1	M/P34594/5

Technical data - Solid state - additional informations see data sheet N/en 4.3.007

Symbol	Voltage (V d.c.)	Current maximum (mA)	Function	Temperature (°C)	LED	Protection class	Plug	Cable length (m)	Cable type	Weight (g)	Model
	10 ... 30	150	PNP	-40 ... +80	•	IP67	—	2, 5 or 10	PVC 3 x 0,12	37	M/50/EAP/*V
	10 ... 30	150	PNP	-40 ... +80	•	IP68	—	5	PUR 3 x 0,14	37	M/50/EAP/5U
	10 ... 30	150	PNP	-40 ... +80	•	IP67	M8 x 1	0,3	PVC 3 x 0,14	16	M/50/EAP/CP *1)
	10 ... 30	150	PNP	-40 ... +80	•	IP67	M12 x 1	0,3	PVC 3 x 0,14	16	M/50/EAP/CC *1)
	10 ... 30	150	NPN	-40 ... +80	•	IP67	—	2, 5 or 10	PVC 3 x 0,12	37	M/50/EAN/*V
	10 ... 30	150	Closer	-40 ... +80	•	IP67	M8 x 1	0,3	PVC 3 x 0,14	16	M/50/EAN/CP *1)

\* Insert cable length; \*1) Plug-in connector below; Color code: BK = black, BN = brown, BU = blue

Drawings

M/50/EAP/\*V,  
M/50/EAN/\*V  
Cable length L = 2, 5 or 10 m

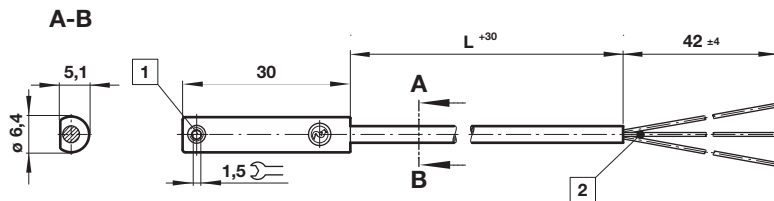

Dimensions in mm  
Projection/First angle



M/50/EAP/CP,  
M/50/EAN/CP

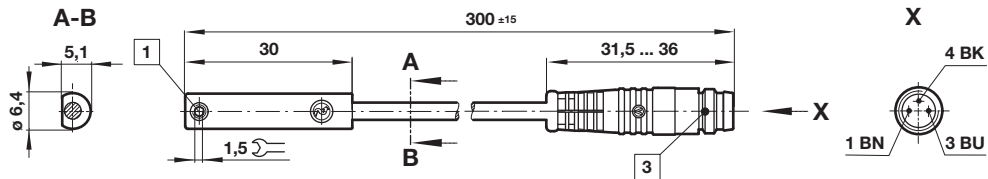

M/50/EAP/CC

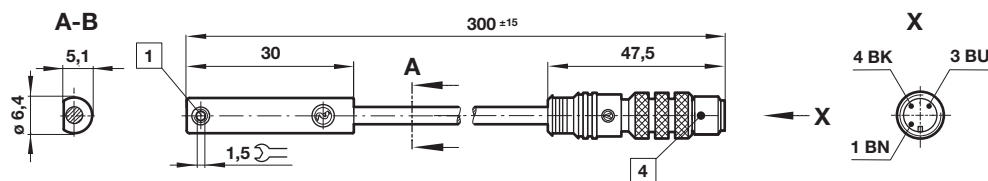

- 1 Fixing screw
- 2 Color code: BK = black; BN = brown; BU = blue
- 3 Plug M8 x 1
- 4 Plug M12 x 1

Warning

These products are intended for use in industrial compressed air systems only. Do not use these products where pressures and temperatures can exceed those listed under

»Technical features/data«.

Before using these products with fluids other than those specified, for non-industrial applications, life-support systems or other applications not within published specifications, consult IMI NORGRN.

Through misuse, age, or malfunction, components used in fluid power systems can fail in various modes.

The system designer is warned to consider the failure modes of all component parts used in fluid power systems and to provide adequate safeguards to prevent personal injury or damage to equipment in the event of such failure.

System designers must provide a warning to end users in the system instructional manual if protection against a failure mode cannot be adequately provided.

System designers and end users are cautioned to review specific warnings found in instruction sheets packed and shipped with these products.