

Sensors and Systems

Edition 3.0



Your automation, our passion.

pf PEPPERL+FUCHS

Technical Data

For detailed data and product description refer to the data sheets at www.pepperl-fuchs.com

General Data

Type of voltage	DC
Operating voltage	10 ... 30 V
No-load supply current	≤ 10 mA
Installation	flush mountable
Reverse polarity protection	✓
Operating current	0 ... 100 mA
Short-circuit protection	pulsing
Indication of the switching state	LED, yellow
Ambient temperature	-25 ... 70 °C (-13 ... 158 °F)
Protection degree	IP67
Housing material	Stainless steel 1.4305 / AISI 303

Model Number

	green = preferred type									
Rated operating distance	0.6 mm									
	1 mm									
Switching element function	NPN NC									
	NPN NO									
	PNP NC									
	PNP NO									
Switching frequency	0 ... 700 Hz									
	0 ... 1300 Hz									
	0 ... 1400 Hz									
Connection type	cable PUR , 2 m									
	cable PVC , 2 m									
	Cable connector M8 x 1 , 3-pin with PVC cable 300 mm									

Approvals and Certificates

UL approval	cULus Listed, General Purpose									
CSA approval	cCSAus Listed, General Purpose									
CCC approval	Products with a maximum operating voltage of ≤36 V do not bear a CCC marking because they do not require approval.									

Dimensions

Length L [mm]	22
Diameter D [mm]	3
Thread length l _t [mm]	0
Cap length l ₁ [mm]	0
Connector area l _c [mm]	0
LED position	Pos. A

Accessories

This and more accessories can be found in chapter 10

See pages from 972 ... for cordsets

See pages 1068 ... for mounting aids

BF 4

Mounting flange, 4 mm

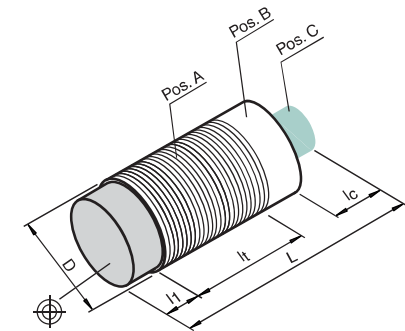

Electrical Connection



NBB0,6-3M22-E0
NBB1-3M22-E0

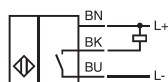

NBB0,6-3M22-E2
NBB1-3M22-E2

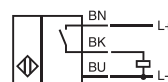

NBB0,6-3M22-E0-0,3M-V3
NBB1-3M22-E0-0,3M-V3

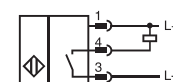

NBB0,6-3M22-E1

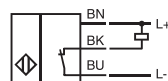

NBB0,6-3M22-E3

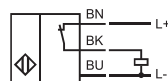

NBB0,6-3M22-E2-0,3M-V3
NBB1-3M22-E2-0,3M-V3

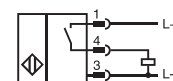

Wire colors in accordance with EN 60947-5-2

1	BN	(brown)
3	BU	(blue)
4	BK	(black)



Properties

- Ø3 mm housing
- Up to 1 mm, flush mountable
- DC, 3-wire switching output
- Cable and pigtail versions